



HTA HT2X00H

Clarity Control Module

ENG

Code/Rev.: M169/80B
Date: 10/27/2022

Phone: +420 251 013 400
clarity@dataapex.com
www.dataapex.com

DataApex Ltd.
Petrzilkova 2583/13
158 00 Prague 5
The Czech Republic

Clarity[®], DataApex[®] and ▲[®] are trademarks of DataApex Ltd. Microsoft[®] and Windows[™] are trademarks of Microsoft Corporation.

DataApex reserves the right to make changes to manuals without prior notice. Updated manuals can be downloaded from www.dataapex.com.

Author: MP

Contents

1 HT2x00H Headspace control module	1
2 Requirements	2
3 Installation Procedure	3
3.1 Autosampler Setup - communication	3
3.1.1 Connections	3
3.2 Clarity Configuration	5
4 Using the control module	8
4.1 Hardware Configuration	8
4.2 Method Setup - AS	8
4.2.1 Method Setup - AS - Basic	9
4.2.2 Method Setup - AS - Advanced	10
4.3 HT2x00H AS Setup	14
4.4 Device Monitor	17
5 Sequence	18
5.1 Optimized Sequence Mode	19
5.2 Single Run	20
6 Troubleshooting	21

To facilitate the orientation in the **HTA HT2x00H** manual and **Clarity** chromatography station, different fonts are used throughout the manual. Meanings of these fonts are:

Instrument (blue text) marks the name of the window to which the text refers.

Open File (italics) describes the commands and names of fields in **Clarity**, parameters that can be entered into them or a window or dialog name (when you already are in the topic describing the window).

WORK1 (capitals) indicates the name of the file and/or directory.

ACTIVE (capital italics) marks the state of the station or its part.

The bold text is sometimes also used for important parts of the text and the name of the **Clarity** station. Moreover, some sections are written in format other than normal text. These sections are formatted as follows:

Note: Notifies the reader of relevant information.

Caution: Warns the user of possibly dangerous or very important information.

Marks the problem statement or trouble question.

Description: Presents more detailed information on the problem, describes its causes, etc.

Solution: Marks the response to the question, presents a procedure how to remove it.

1 HT2x00H Headspace control module

This manual describes the setting of the **HTA** autosamplers described in the table below. The control module enables direct control of the instrument over **LAN**.

Autosampler	Type
HT2000H	Headspace autosampler
HT2000HT	Headspace autosampler (support for high temperatures)
HT2100H	Headspace autoinjector
HT2800T	All-in-one (setting in this manual is relevant to headspace mode only)



Fig 1: HT2100H Headspace

Direct control means that the autosampler can be completely controlled from the **Clarity** environment. Instrument method controlling the sample preparation conditions will be saved in the measured chromatograms

Note: Sample preparation conditions are all the options from the [Method Setup - AS - Basic/Advanced](#) dialogs.

2 Requirements

- **Clarity** Installation with AS Control module (p/n A26).
- Computer and autosampler connected to the same LAN (Ethernet network), autosampler connected by crossed UTP cable (p/n SK08).

Note: Cables are not part of **Clarity** control module. It is strongly recommended to order required cables together with **Clarity** or the control module.

Autosampler	Firmware (minimum)
HT2000H	1.02
HT2000HT	1.17
HT2100H	1.02
HT2800T	1.02

For firmware update, please contact HTA company.

3 Installation Procedure

3.1 Autosampler Setup - communication

3.1.1 Connections

Besides the network connection, following connections must be made to the **autosampler GC connector**:

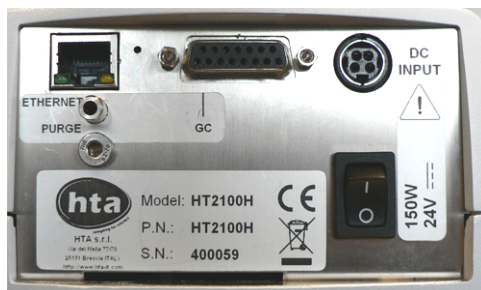

Fig 2: Autosampler connectors

- The GC **Start Output** can be connected to **Clarity IN** cable.

The designations of pins on the HT2x00H samplers are dependent on model number and are described in the following table:

Tab 1: HT2x00H - designations of pins:

Connection	Clarity cable	15 pin connector	PIN
Start	IN (red)	SAMPINS_NO	3 (close) or 15 (open)
	IN (shield)	SAMPINS_COM	6
Ready	OUT (red)	GC_READY NON	9
	OUT (red)	GC_READY	4
	OUT (shield)	GND	5

Refer to HTA manual for description of cables supplied with the autosampler.

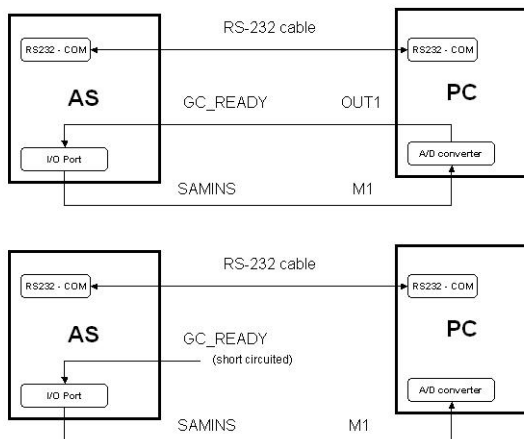

Fig 3: HT2x00H scheme of connections

Note: Typical wiring of controlled instruments is described in the **Clarity Getting Started** manual.

3.2 Clarity Configuration

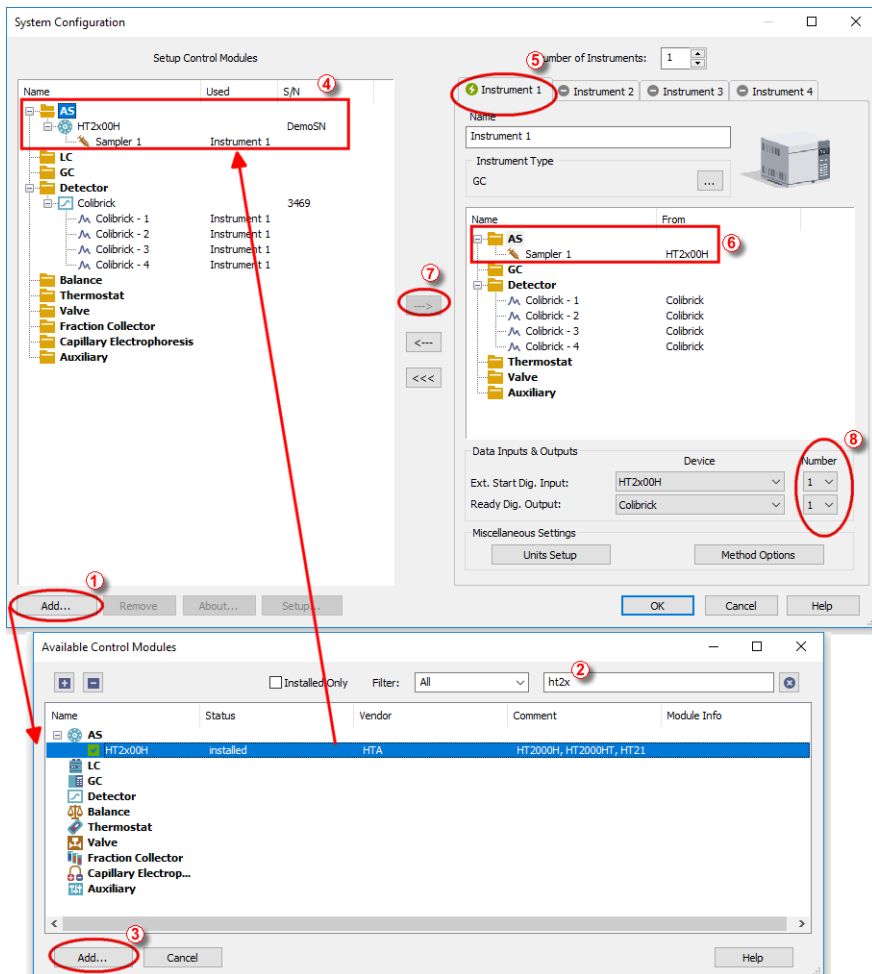



Fig 4: System Configuration



- Start the **Clarity** station by clicking on the  icon on the desktop.
- Invoke the **System Configuration** dialog accessible from the **Clarity** window using the *System - Configuration...* command.
- In the **System Configuration** dialog press the *Add* button to invoke the **Available Control Modules** dialog.

- You can specify the searching filter ② to simplify the finding of the driver.
- Select the **HT2x00H** and press the *Add* ③ button.

The **HT2x00H Setup** dialog will appear.

Fig 5: HT2x00H AS Setup

- Fill in the *IP Address* and press the *AutoDetect* button to load the parameters and press the *OK* button.

Note: Other fields from this dialog are described later in the manual (for more details see the chapter **HT2x00H AS Setup** on pg 14)..

The *HT2x00H* appears in the *Setup Control Modules* list of the **System Configuration** dialog.

- Drag and drop the **HT2x00H** icon from the *Setup Control Modules* list ④ on the left side of the **System Configuration** dialog to the desired *Instrument* ⑤ tab on the right side ⑥ (or use the  button ⑦ to do so).
- Set the *Start* and *Ready* input and output numbers ⑧ for your acquisition card according to the wires used for synchronization. If you wish to synchronize the **Clarity** start with the autosampler via digital communication, you can set the **HT2x00H** in the *Ext. Start Dig. Input* drop-down menu, using the *1* as a input *Number*. In such case it is necessary to change the behavior on the **Method Setup - Measurement** tab later from *Down* to *Up*, else the start signal will be delayed by pulse length (approximately 2 seconds).

Note: The configuration dialog of the **HT2x00H** autosampler (**HT2x00H Setup**) can be displayed any time by double-clicking on its icon or using the *Setup* button.

4 Using the control module

New [Method Setup - AS](#) tab appears in the [Method Setup](#) dialog, enabling the setting of the AS control method.

4.1 Hardware Configuration

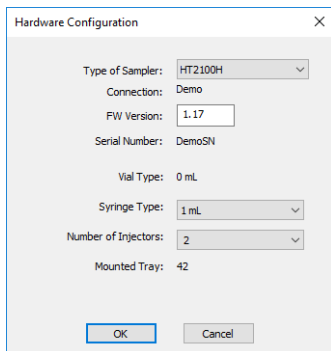

Fig 6: Hardware Configuration

In the full version, this dialog displays communication settings and some parameters of the sampler, like vial and syringe type, number of injectors and tray size.

Note: In the demo version parameters can be set according to real possibilities of the sampler and *FW Version* needs to be present in the form *x.yy*.

4.2 Method Setup - AS

The *AS Status* button displays the [Hardware Configuration](#) dialog described on [pg 8](#).

Sending injection method to sampler

The injection method is sent to the autosampler:

- Automatically by the **Clarity Sequence**.
- Automatically in cases specified in the [Instrument Method Sending](#) dialog accessible from the [System Configuration](#) dialog using the icon.
- Manually using the *Send Method* button in the Single Analysis dialog.

Downloading injection method from sampler

The *From AS* button in the [Method Setup - AS](#) dialog serves for downloading the injection method from the sampler.

Caution: If you have injection methods already established in the sampler, it is advisable to download them to **Clarity** using the *From AS* button and save them as a **Clarity** method.

4.2.1 Method Setup - AS - Basic

Basic and washing parameters of the method.

The screenshot shows the 'Method Setup Default1 (MODIFIED)' window. The 'Basic' tab is selected, showing parameters for the 'HTA HT200H Sampler Method'. The 'AS Status...' button is highlighted in blue. The 'From AS' button is also visible. The 'AS Status...' button is highlighted in blue.

Fig 7: Method Setup - AS Control - Basic

Analysis Time

Estimated duration of analysis - sampler uses this value to optimise sample preparation times.

Valid range: 00:02 - 23:59.

Conditioning Time

Duration of sample conditioning.

Valid range: 00:00 - 23:59.

Oven Temp.

Temperature of oven during analysis.

Autosampler	Valid temperature
HT2000H	0 (OFF) or 40 - 170 °C
HT2000HT	0 (OFF) or 40 - 300 °C
HT2100H	0 (OFF) or 40 - 150 °C
HT2800T	0 (OFF) or 40 - 170 °C

Syringe Temp.

Temperature of syringe during analysis.

Valid range: 0 (OFF) or 40 - 150 °C.

For HT2000HT valid range: 0 (OFF) or 40 - 250 °C

Shake On / Off Time

Times in which oven shaker is turned on/off during sample conditioning. When conditioning time is longer than shaker times, shaker cycles on and off.

Valid range: 0 - 9.9 ± 0.1 min

Setting times to 0 turns shaker off.

Pre / Post Injection Dwell Time

Time that sampler waits prior to and after injection with syringe in injector in order to equilibrate.

Valid range: 0 - 99 ± 1 s.

Electro Valve Flush Time

The time syringe is flushed with gas after injection.

Valid range: 0 - 9.9 ± 0.1 min.

When vial is missing

Sets the behavior of the sampler when no vial is found in the desired position in the tray,

4.2.2 Method Setup - AS - Advanced

Volume and speed settings.

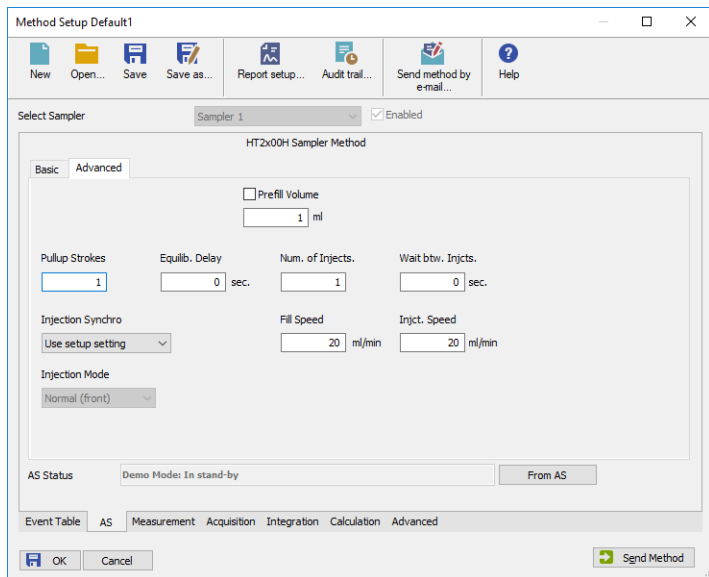

Fig 8: Method Setup - AS Control - Advanced

Prefill Volume

When checked, the specified volume of air is injected into the sample prior to aspiration.

Valid range: $0 - 4.5 \pm 0.01$ ml

Pullup Strokes

Number of pullup strokes of the plunger prior to sample aspiration - useful for mixing the sample.

Valid range: $0 - 15$

Equilib. Delay

The time the syringe stays in sample during each pullup stroke.

Valid range: $0 - 60 \pm 1$ s

Num. of Injects.

When GC is equipped with proper trapping system, multiple injections can be used to increase total volume of sample used for analysis.

Valid range: $1 .. 15$

Wait btw. Injects.

If multiple injections are used, sampler waits for given time between consecutive injections with syringe in injector in order to equilibrate.

Valid range: $0 - 99 \pm 1$ min

Injection Syncro

Type of synchronization with GC - controls precise moment when *Injected* signal is sent to GC. It is possible to use settings from the setup or set it

individually for each method. It is not possible to change this setting when "Use Optimized Sequence" checkbox is checked in [HT2x00H Setup](#).

Note: DIN synchronization is available for HT2000H and HT2100H since firmware 1.17 and higher, for HT2800T is disabled.

Tab 2: Possible values for Injection Synchro:

Synchronization	Output (signal to GC)	Start injection (signal from GC)
Normal	At the beginning of the syringe plunger movement.	At the reception of the GC Ready signal.
Trigger	At the beginning of the syringe plunger movement.	At the reception of the GC Ready. After ending the sample preparation it emits a SYNC-OUT signal.
A-start	When sensor touches the injector	At the reception of the GC Ready signal.
Delayed	At the end of the syringe plunger movement.	At the reception of the GC Ready signal.
EA	At the beginning of the syringe plunger movement.	At the contemporaneous reception of the GC Ready signal and of the SYNC-IN signal.
Normal without Ready	At the beginning of the syringe plunger movement.	At the end of the analysis time set in the autosampler method.
DIN (for special application only)	At the beginning of the syringe plunger movement.	At the reception of the GC Ready signal.

Fill Speed

Speed of sample aspiration.

Valid range: $0.1 - 100 \pm 0.01$ ml/min

Injection Speed

Speed of sample injection.

Valid range: $0.1 - 100 \pm 0.01$ ml/min

When two injectors are configured, parameter Injection mode can be specified to one of following values:

Injection Mode

Sets the mode of the operation in case the two injectors are defined on the **HT2x00H** autosampler. The following options are available:

Normal (front) - injection into the front injector; this is the default mode for one injector.

Rear - injection into the rear injector.

Confirmation - injection of one sample into both injectors.

4.3 HT2x00H AS Setup

The [HT2x00H AS Setup](#) dialog sets the fundamental options of the control module.

Note: It is accessible from the [System Configuration](#) dialog by doubleclicking the *HT2x00H* item.

Fig 9: HT2x00H AS Setup

IP Address

Sets the IP address of the sampler connected to LAN.

Note: For more details see the chapter **Installation Procedure** on pg 3..

AutoDetect

By clicking this button the type and settings of the autosampler will be read automatically from the IP Address.

Sampler Name

Sets the name of the autosampler displayed in **Clarity**.

Oven Standby Temp.

Sets the temperature of oven in standby mode.

Autosampler	Valid temperature
HT2000H	0 (OFF) or 40 - 170 °C
HT2000HT	0 (OFF) or 40 - 300 °C
HT2100H	0 (OFF) or 40 - 150 °C
HT2800T	0 (OFF) or 40 - 170 °C

Syringe Standby Temp.

Sets the temperature of syringe in standby mode.

Valid range: 0 (OFF) or 40 - 150 °C.

For HT2000HT valid range: 0 (OFF) or 40 - 250 °C

Injection Synchronization

Sets the default synchronization mode between the autosampler and the analyzer or other instruments during the execution of one or more injections. It can be set to different one in each method in the [Method Setup - AS - Advanced](#).

Note: DIN synchronization is available for HT2000H and HT2100H since firmware 1.17 and higher, for HT2800T is disabled.

A-start Wait Time

Set the delay between the A-start event and actual sending the signal to the GC. This delay cannot be set when setting the *A-start* option in the [Method Setup - AS](#) dialog.

Tab 3: Possible values for Injection Synchro:

Synchronization	Output (signal to GC)	Start injection (signal from GC)
Normal	At the beginning of the syringe plunger movement.	At the reception of the GC Ready signal.
Trigger	At the beginning of the syringe plunger movement.	At the reception of the GC Ready. After ending the sample preparation it emits a SYNC-OUT signal.
A-start	When sensor touches the injector.	At the reception of the GC Ready signal.
Delayed	At the end of the syringe plunger movement.	At the reception of the GC Ready signal.
EA	At the beginning of the syringe plunger movement.	At the contemporaneous reception of the GC Ready signal and of the SYNC-IN signal.
Normal without Ready	At the beginning of the syringe plunger movement.	At the end of the analysis time set in the autosampler method.
DIN (for special application only)	At the beginning of the syringe plunger movement.	At the reception of the GC Ready signal.

Flush Electro Valve in Standby

When checked, autosampler flushes electro valve and syringe with gas in standby mode.

This checkbox is unchecked by default.

Use Optimized Sequence

When checked, samples are prepared in advance to speed up analysis - For more details see the chapter **Installation Procedure** on pg 3..

This checkbox is unchecked by default. When active, it is not possible to select *Injection Synchro* in [Method Setup - AS - Advanced](#).

4.4 Device Monitor

Device Monitor of the **HT2x00H Headspace** displays the status information from the autosampler.

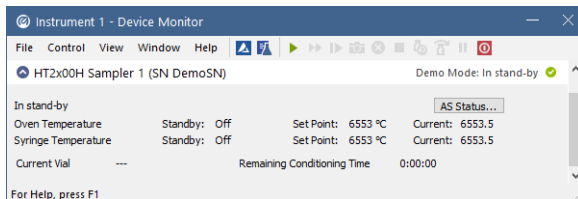

Fig 10: Device Monitor of the HT2x00H

AS Status

Displays the **Hardware Configuration** dialog describing the communication parameters and settings of the sampler.

5 Sequence

To use the autosampler in the **Clarity** sequence, following conditions must be met:

- The sequence must be saved.
- The sequence must be set as **Active Sequence**.
- All used methods must have the *External Start* enabled and the *Autostop* time set.
- The *Use Optimized Sequence* checkbox in the **HT2x00H AS Setup** dialog must be checked (when using the parallel sample preparation).
- **Method Setup - AS** dialog in the used methods must be filled in.

The required values for starting vial (*SV*), ending vial (*EV*), number of injections from vial (*IV*) and injected volume are set in the sequence table.

The *Sample Volume* field from the **Method Setup - AS** dialog is used only in **Single Run** injections.

Standard sequence operation

After sequence start, the AS control method will be sent to the sampler and the datastation will wait for the injection signal from sampler. After receiving it, the run starts and after finishing, the method for next injection will be sent to the sampler.

Note: The headspace sampler can prepare next samples in advance while measuring the current sample. This function is enabled in the **Optimized Sequence Mode** described in the following chapter.

5.1 Optimized Sequence Mode

In *Optimized Sequence Mode* the samples are prepared in advance in order to shorten total analysis time. While sampler injects and waits for analysis of one sample, it prepares and conditions subsequent samples in parallel. All rows that are being prepared are already locked (protected against editation) in the **Clarity Sequence** table.

In the following example while sampler is injecting vial 63, vials 70 - 72 are already being prepared:

Status	Run	SV	EV	I/V	Sample ID	Sample	Sample Amount	ISTD1 Amount	Sample Dilut.	Inj. Vol. [µL]	File Name	Lvl	Method Name	Open	Open Calib.	Print
✓	1	1	1	1			0.000	0.000	1.000	0.000	%q_%R_...	Default1	Default1	✓		
✓	2	2	2	1			0.000	0.000	1.000	0.000	%q_%R_...	Default1	Default1	✓		
✓	3	3	3	1			0.000	0.000	1.000	0.000	%q_%R_...	Default1	Default1	✓		
✓	4	4	4	1			0.000	0.000	1.000	0.000	%q_%R_...	Default1	Default1	✓		
✓	5	5	5	1			0.000	0.000	1.000	0.000	%q_%R_...	Default1	Default1	✓		
✓	6	6	6	1			0.000	0.000	1.000	0.000	%q_%R_...	Default1	Default1	✓		
	7															

Fig 11: Sequence table

The **Optimised Sequence Mode** requires the **Use Optimized Sequence** checkbox in the [HT2x00H AS Setup](#) dialog to be checked.

Tips for using Optimized Sequence Mode

To take full advantage of this mode, several guidelines should be followed when preparing sequence in the **Clarity** station:

- Use single **injection per vial**.

Note: Optimised Sequence Mode does not support multiple injections from one vial.

- Use the same **Injection Volume** and **Method Name** in consecutive rows as much as possible. Each change of method or injection volume (which is part of injection method of the sampler) forces sampler to discontinue optimization due to different preparation conditions defined in the injection method.

Note: An example can be seen in the previous figure between vials 72 and 73, where optimization was stopped when method name changed.

- Use consecutive vial numbers. The sampler optimizes only samples from continuous sequence of vials. This continuous sequence can be spanned across multiple rows of **Clarity Sequence table** (in order to change values that do not affect behaviour of the sampler, e.g. **File Name**, **Sample ID**, etc.).

Caution: Pause command invokes abort of autosampler, which causes break of Sequence optimization.

5.2 Single Run

The AS control is usually used in the *Sequence* measurement. For *Single Run* operation, the selected method should be sent to the sampler using the *To AS* button from the [Method Setup - AS](#) dialog. In case the **OUT** wire is connected to the sampler, the initial state of the respective digital output must be set to *LOW* in the [Digital Outputs](#) dialog accessible from the [Clarity](#) main window *System* menu. The vial numbers must be entered and the injection started from the Sampler keyboard. The *Analysis Time* set in the [Method Setup - AS](#) dialog governs the injection cycle.

Note: That means: if it is shorter than the *Autostop Time* in the [Method Setup - Measurement](#) dialog, the sampler can inject next sample before the previous run acquisition has been finished.

The *Sample Volume* field in the [Method Setup - AS](#) dialog is used for injection.

6 Troubleshooting

When the remedy for some problem cannot be discovered easily, the recording of communication between and the detector can significantly help the **DataApex** support to discover the cause of the problem.

The recording can be enabled by adding or amending the COMMDRV.INI file in the installation directory (C:\CLARITY\CFG by default). The file can be edited in any text editor (e.g. Notepad). Following section should be edited or added:

```
[TCP_IP 192.168.0.207:2101]
echo=on
textmode=on
filename=HTA2x00H.txt_%D
reset=off
```

Note: Instead of *192.168.0.207:2101* type correct IP address and port used for communication with the autosampler. IP address and port is displayed in the [Hardware Configuration](#) dialog.

Note: *%D* (or *%d*) in the filename parameter means that the log will be created separately for each day. The *reset=off* parameter disables deleting the content of the log each time the station is started during the same day.

The created *.txt files will greatly help in diagnosis of unrecognized errors and problems in communication.