



SPARK ENDURANCE

Clarity Control Module

ENG

Code/Rev.: M119/80B
Date: 10/27/2022

Phone: +420 251 013 400
clarity@dataapex.com
www.dataapex.com

DataApex Ltd.
Petrzilkova 2583/13
158 00 Prague 5
The Czech Republic

Clarity[®], DataApex[®] and ▲[®] are trademarks of DataApex Ltd. Microsoft[®] and Windows[™] are trademarks of Microsoft Corporation.

DataApex reserves the right to make changes to manuals without prior notice. Updated manuals can be downloaded from www.dataapex.com.

Author: MP

Contents

1 Spark Holland Endurance control module	1
2 Requirements	2
3 Installation Procedure	3
3.1 Hardware - Wiring	3
3.2 Spark Endurance setup - communication	4
3.2.1 Connections	5
3.3 Clarity Configuration	6
4 Using the control module	8
4.1 Method Setup - AS	8
4.1.1 Injection & Wash	9
4.1.2 Timebase	12
4.1.3 Mix	14
4.1.4 User Program	16
4.1.5 System	19
4.1.6 Vials	21
4.2 Hardware Configuration	22
4.3 Spark Autosampler Setup	23
5 Report Setup	24
6 Troubleshooting	25
6.1 Specific Problems	26

To facilitate the orientation in the **Spark Endurance** manual and **Clarity** chromatography station, different fonts are used throughout the manual. Meanings of these fonts are:

Instrument (blue text) marks the name of the window to which the text refers.

Open File (italics) describes the commands and names of fields in **Clarity**, parameters that can be entered into them or a window or dialog name (when you already are in the topic describing the window).

WORK1 (capitals) indicates the name of the file and/or directory.

ACTIVE (capital italics) marks the state of the station or its part.

The bold text is sometimes also used for important parts of the text and the name of the **Clarity** station. Moreover, some sections are written in format other than normal text. These sections are formatted as follows:

Note: Notifies the reader of relevant information.

Caution: Warns the user of possibly dangerous or very important information.

Marks the problem statement or trouble question.

Description: Presents more detailed information on the problem, describes its causes, etc.

Solution: Marks the response to the question, presents a procedure how to remove it.

1 Spark Holland Endurance control module

This manual describes the setting of the **Spark Holland Endurance** autosampler. The control module enables direct control of the instrument over serial line.



Fig 1: Spark Holland Endurance

Direct control means that the autosampler can be completely controlled from the **Clarity** environment. Instrument method controlling the sample preparation conditions will be saved in the measured chromatograms.

Note: It is recommended to check the user manual of the autosampler for its operating principles and restrictions.

2 Requirements

- **Clarity** Installation CD ROM with AS Control module (p/n A26).
- Free serial COM port in the PC.

Note: Modern computers usually have only 1 (if any) serial (COM) port installed. To use more devices requiring the port, the **MultiCOM** adapter (p/n MC01) is available.

- Serial straight DB9F-DB9M cable (p/n SK02).

Note: Cables are not part of **Clarity** Control Module. It is strongly recommended to order required cables together with the Control Module.

3 Installation Procedure

3.1 Hardware - Wiring

Commands for the autosampler are communicated with **Clarity** through the Serial straight DB9F-DB9M (p/n SK02) cable. It may be, however, necessary to use additional starting cable, when no other part of the instrument is directly controlled. The signal cable has to be connected according to the following scheme.

Note: Typical connections of a set with Autosampler can be found in the **Getting Started** manual (chapter **Device Setup and Wiring**).

Typical serial cable wiring is described in the picture:

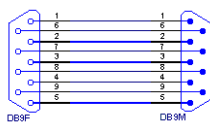

Fig 2: Serial straight DB9F - DB9M cable

3.2 Spark Endurance setup - communication

The **Spark Endurance** autosampler has to be set in the *SERIAL MODE* in order to function correctly with its **Clarity Control module**. This is done by pressing the *Serial* Soft Function key from the main menu on the sampler keyboard. In addition, the *ID* of the **Spark Endurance** autosampler must be the same that will be later set in **Clarity**. To find out or change the autosampler *ID*, perform the following steps:

- Enter the *System Menu* on the **Spark Endurance** autosampler keyboard by pressing the **System** button.
- Use the *COMM.* command to set the device identifier ID. Any value in the range 20 - 29 is valid.

Moreover, the **Spark Endurance** autosampler has the Multi Link Port present on the rear side, and in order to communicate with **Clarity** correctly, its configuration must be set according to the following image:

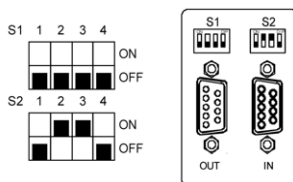

Fig 3: Multi Link Port settings

3.2.1 Connections

- For the start synchronization with LC the *Start* output must be connected with **Clarity Starting cable IN**.

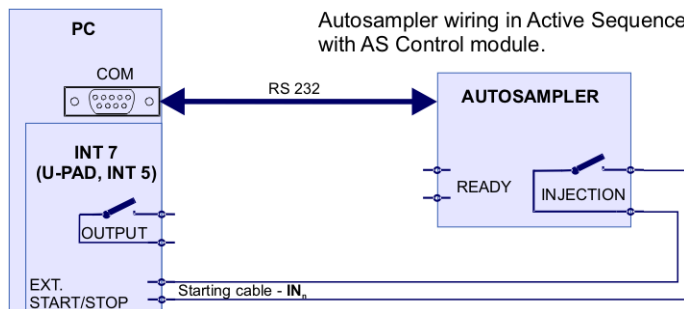

Fig 4: Wiring of an autosampler with AS Control module

- Do not connect the digital output cable **OUTnR**.
- The starting cable **INn** must be connected.

Note: **Clarity** standard cable (along with further details on wiring) is described in the **Clarity Getting Started** manual.

- The **Spark Endurance** autosampler accessories include the **Start marker** cable (15 pin Sub D connector to 2 free leads). Connect the leads on this cable to leads on the **Clarity Starting cable INx** cable extension.
- Consult the user manual for **Spark Endurance** autosamplers for details about wiring and connectors on the device.

3.3 Clarity Configuration

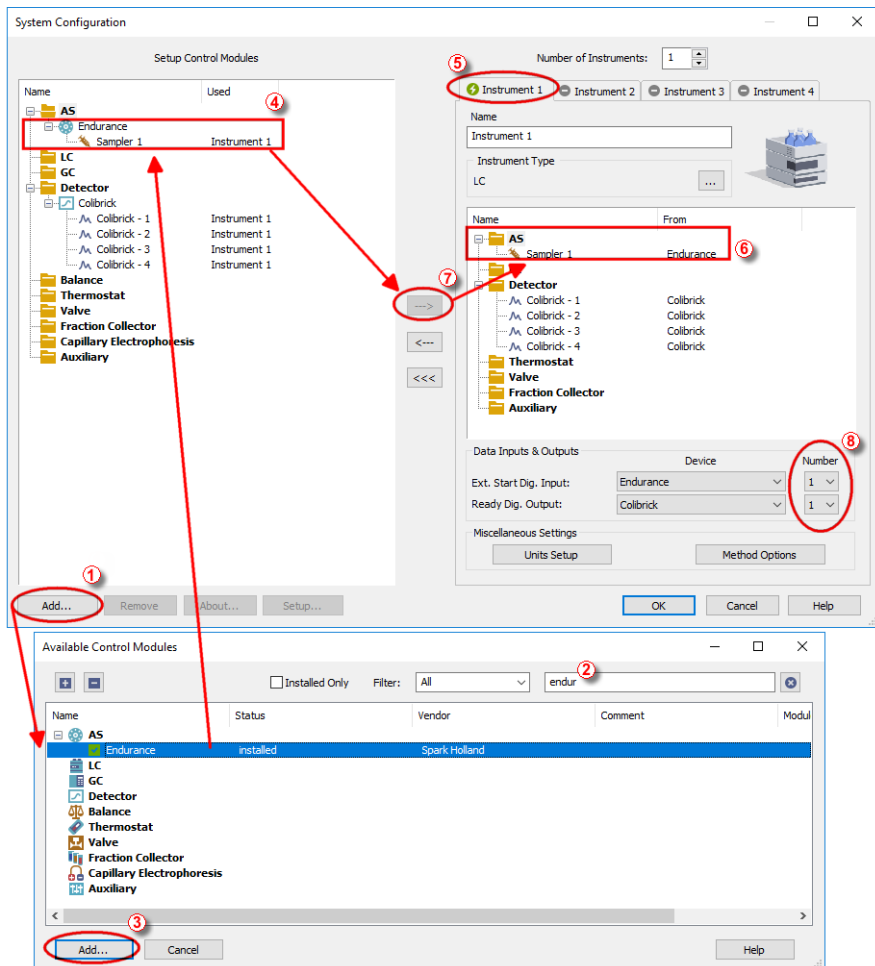



Fig 5: System Configuration



- Start the **Clarity** station by clicking on the  icon on the desktop.
- Invoke the **System Configuration** dialog accessible from the **Clarity** window using the *System - Configuration...* command.
- Press the **Add** button ① (see **Fig 5** on pg 6.) to invoke the **Available Control Modules** dialog.

- You can specify the searching filter ② to simplify the finding of the driver.
- Select the **Endurance** sampler and press the *Add* ③ button.

The **Spark Autosampler Setup** dialog will appear.

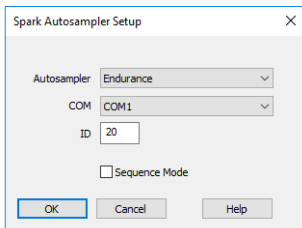

Fig 6: Spark Autosampler Setup

- Select the correct type of the *Autosampler* and fill in the *COM* and *ID* fields, then press the *OK* button. The *ID* must match the device identifier set previously in the autosampler setup, as described in the chapter "**Spark Endurance setup - communication**" on pg 4.

Caution: The **Spark Autosampler Setup** dialog is more closely described in the chapter "**Spark Autosampler Setup**" on pg 23.

The **Endurance** autosampler item will appear in the *Setup Control Modules* list of the **System Configuration** dialog.

- Drag and drop the **Endurance** icon from the *Setup Control Modules* ④ list on the left side of the **System Configuration** dialog to the desired *Instrument* ⑤ tab on the right side ⑥ (or use the *---* button ⑦ to do so).
- Set the *Ext. Start Dig. Input* and *Ready Dig. Output* numbers ⑧ for your acquisition card according to the wires being used for synchronization. If you wish to synchronize the **Clarity** with the autosampler, you can set the **Endurance** in the *Ext. Start Dig. Input* drop-down menu.

4 Using the control module

New [Method Setup - AS](#) tab appears in the [Method Setup](#) dialog, enabling the setting of the **Spark Endurance** autosampler control method.

4.1 Method Setup - AS

The *Method Setup - AS* dialog consists of six sub-tabs assigned for the various parts of the **Spark Endurance** autosampler method. These sub-tabs are [Injection & Wash](#), [Timebase](#), [Mix](#), [User Program](#), [System](#) and [Vials](#). Additional buttons allow to display the [Hardware Configuration](#) dialog of the **Spark Endurance** autosampler or to read the instrument method from the **Spark Endurance** autosampler. The method is sent to the autosampler every time the *Send Method* or *OK* button is pressed. Other actions in different windows may also cause the sending of the instrument method to the controlled devices including the **Spark Endurance** autosampler - most notable cases being pressing the *Send Method* button in the [Single Run](#) dialog or starting a new injection from the [Sequence](#) window (each injection is preceded with sending the instrument method).

To read the **Spark Endurance** method from the autosampler it is necessary to use the *From AS* button available from all sub-tabs of the [Method Setup - AS](#) dialog. If the injection method is already established in the sampler, it is advisable to download it to **Clarity** using the *From AS* button and save it as a **Clarity** method.

4.1.1 Injection & Wash

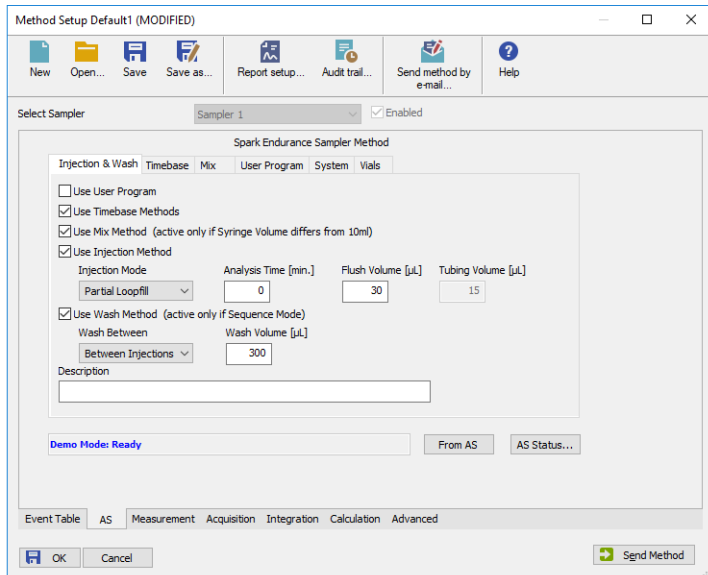

Fig 7: Method Setup - AS - Injection & Wash

This is the main tab defining the AS control method. It defines which parts of the **Spark Endurance** method will be performed and set some other parameters.

The options on this tab consist of two parts, which exclude themselves - if the *Use User Program* option is selected, no other options will be used. On the other hand, if the *Use User Program* checkbox is not checked, any combination of other method parts may be used.

Use User Program

When set, the whole injection part of the method will be governed by instructions set on the [Method Setup - AS - User Program](#) tab.

Use Timebase Methods

Sets whether the sampler method part used for outputting signals after injection will be used. This part of the method is then set on the [Method Setup - AS - Timebase](#) tab.

Use Mix Method

Sets whether the sample pre-preparation part of the injection method will be used. If checked, the method defined on the [Method Setup - AS - Mix](#) tab will be performed.

Use Injection Method

This part of method contains the information on the injection routine, analysis time and flush volume.

Injection Mode

Allows to set the injection mode by selecting one of the possibilities:

Partial Loopfill - in this mode, only a part of the sample loop volume will be transferred into the column.

Full Loop - in this mode, the full sample loop will be transferred to the column. Only the value set in the *Loop Volume* field of the **Method Setup - System** dialog is allowed for setting in the *Inj. Vol.* column in the **Sequence Table** in the **Sequence** window.

µl Pick up - defined volume of the sample will be injected into the column, preceded and followed by the transport liquid.

Analysis Time [min.]

Defines the time between switching the injection valve to the *INJECT* position and the start of next sample preparation.

Caution: While using the synchronization wire for the **Endurance** autosampler, it is necessary to set the analysis time to 0.

Flush Volume [µl]

Defines the volume of the sample that will be used for flushing the sample loop and tubing before the sample is aspirated. Possible values range from 0 to 999 µl, default value is 30 µl. This option is only available for the *Partial Loopfill* and *Full Loop* injection modes.

Caution: Setting the *Flush Volume* parameter to less than twice the volume of the needle and tubing will cause worse performance.

Tubing Volume [µl]

Defines the tubing volume. Possible values range from 1 to 32 µl. This parameter is only editable when *µl Pick up* injection mode is performed.

Use Wash Method

Defines the type of the washing method performed between injections/samples/sequences. This section is only editable if the *Sequence Mode* option is checked in the **Spark Autosampler Setup** dialog.

Wash Between

Defines the time when the wash should be performed. Possible values are:

Between Series - the wash will be performed only after each finished sequence.

Between Samples - the wash will be performed after each sample measured.

Between Injections - the wash will be performed after each injection.

Wash Volume [μ l]

Defines the volume of the solvent used for the wash. The value has to fall into the 300 - 9999 μ l interval.

Description

Field for the description of the AS control method. This description is purely informational.

4.1.2 Timebase

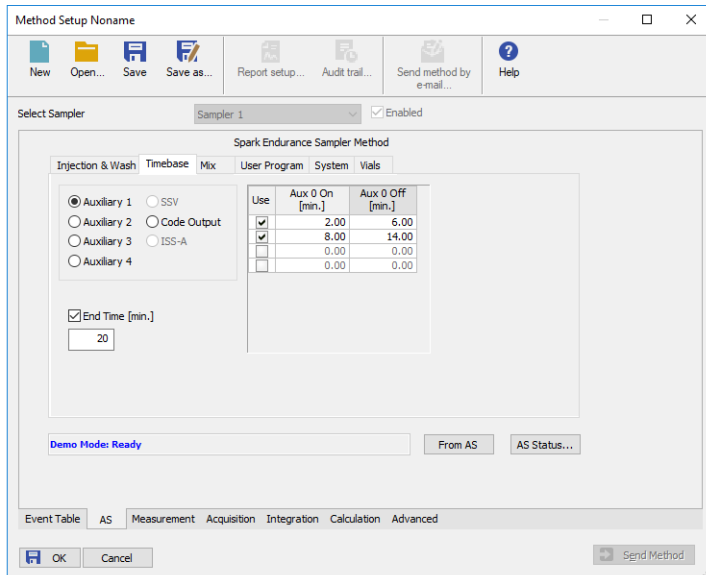

Fig 8: Method Setup - AS - Timebase

This section serves for the control over the digital outputs via timed events. Only five digital outputs at a time may be programmed in one method.

Auxiliary 1 (..4)

Invokes the Auxiliary output with the particular output number. In the **Timebase table**, set the time interval in which the output will be set to **HIGH**. Each row of the table represents one time interval for the particular output.

SSV

Defines the output signals set to the optional Solvent Selection Valve (SSV). The valve must be present in order to be able to set outputs for it. Define the time and the port to be used in the **Timebase table**. It is possible to select up to 8 events for the valve during each run.

Code Output

Serves as a hexadecimal output. Enter the time and the value between 1 and 15, other values will not be accepted.

ISS-A

Defines the output signals set to the optional Integrated Stream Switching (ISS) 6-port valve. The valve must be present in order to be able to set outputs for it. It is possible to fill in up to 4 rows for the valve during each

run, each governing the switch of the valve to a the other position and back based on the analysis time.

End Time [min.]

Sets the end time for **Timebase** program. If no value is filled in, the Endurance will automatically generate the *End Time* equal to the *Analysis Time* parameter programmed on the [Method Setup - AS - Injection & Wash](#) sub-tab.

Caution: Do not set the *End Time* parameter while the *Sequence Mode* (switched in the [Spark Autosampler Setup](#) dialog) is used.

Timebase table

The columns in the **Timebase table** are context-based according to the selected output. Each signal has its own **Timebase table**, which allows to invoke its output based on the analysis time. All *Auxiliary* and *A/ISS-A* signals may be switched on and off again up to four times during each analysis run, while the *SSV* and *Code Output* signal may be invoked eight times during each run. Rows in the table can be edited only after the checkbox in the *Use* column is checked, the time values are set in minutes in decimal format (e.g. 2 minutes 45 seconds should be written as 2.75).

4.1.3 Mix

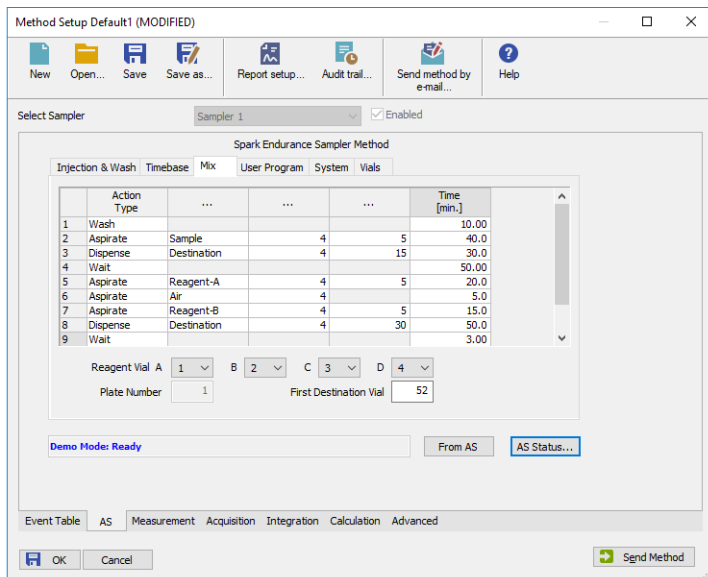

Fig 9: Method Setup - AS - Mix

Mix part of the sampler method (defined on the [Method Setup - AS - Mix](#) sub-tab) governs the pre-preparation of sample before the injection. Several operations are possible with vials defined on the [Method Setup - AS - Vials](#) tab. The table column headings are context-based, that is they change according to the action selected in the first column on the actual row. These operations are:

Aspirate

Draws the solution from the specified vial or the wash solution into the syringe. The source is specified in the *From* column, the volume aspirated in the *Amount [μl]* column. Furthermore it is necessary to specify the speed of the aspiration in the *Speed* column (in the range 1-slowest to 9-fastest) and the height of the needle tip above the vial bottom in the *Height [mm]* column (see *Needle Height* parameter on the [Method Setup - AS - System](#) tab - this option is not available for the aspiration from the wash solution).

Dispense

Empties a given volume from the syringe into the specified vial or waste port. The volume to be dispensed is set in the *Amount [μl]* column, the destination vial is set in the *To* column. Furthermore, the height of the needle tip above the bottom of the vial tray and the speed of emptying is set in the *Height [mm]* and *Speed* columns, respectively. The meaning of

these columns is the same as in the *Aspirate* command, dispensing into the Waste port doesn't need to specify the *Height* parameter.

Wait

Causes the sampler to wait for the specified time interval. The desired interval is entered into the *Time [min.]* column in minutes.

Repeat

Repeats the last one or more rows for the specified number of times. The *Repeat* column is used to set the number of repeats, the *Steps* column sets the number of **Mix table** rows to be repeated.

Wash

Performs the standard wash operation. Specify the volume of the wash solvent in the *Amount [μ l]* column.

4.1.4 User Program

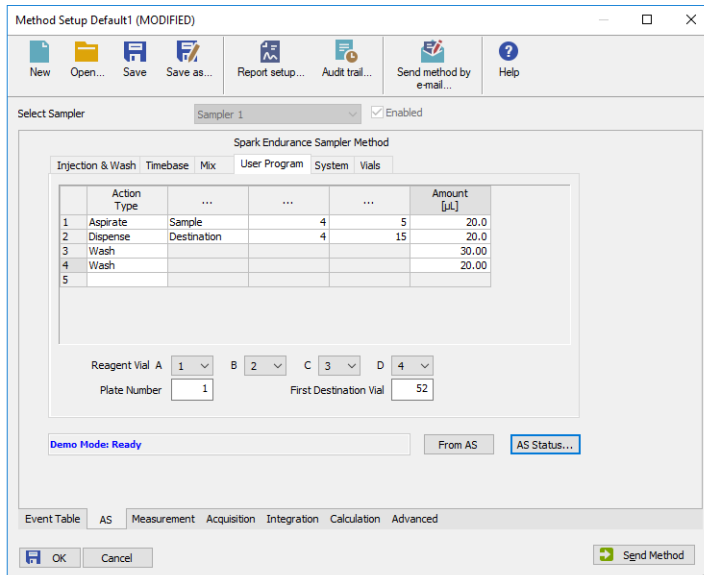

Fig 10: Method Setup - AS - User Program

The table on the [Method Setup - AS - User Program](#) tab enables to set all parts of the sampler method in one place, which means that no parameters on [Injection & Wash](#), [Timebase](#) and [Mix](#) tabs will be necessary. [User Program](#) tab thus substitutes all tabs mentioned above and checking the checkbox on [Method Setup - AS - Injection & Wash](#) tab will disable all other checkboxes there.

This table enables to perform several actions. The table column headings are context-based, that is they change according to the action selected in the first column on the actual row. Possible actions are:

Aspirate

Draws the solution from the specified vial or the wash solution into the syringe. The source is specified in the *From* column, the volume aspirated in the *Amount [µL]* column. Furthermore it is necessary to specify the speed of the aspiration in the *Speed* column (in the range 1-slowest to 9-fastest) and the height of the needle tip above the vial bottom in the *Height [mm]* column (see [Needle Height](#) parameter on the [Method Setup - AS - System](#) tab - this option is not available for the aspiration from the wash solution or aspiration of the Air).

Dispense

Empties a given volume from the syringe into the specified vial or waste port. The volume to be dispensed is set in the *Amount [µL]* column, the

destination vial is set in the *To* column. Furthermore, the height of the needle tip above the bottom of the vial tray and the speed of emptying is set in the *Height [mm]* and *Speed* columns, respectively. The meaning of these columns is the same as in the *Aspirate* command, dispensing into the Waste port doesn't need to specify the *Height* parameter.

Syr-Valve

Switches the syringe valve to one of its three positions: *Needle*, *Wash* and *Waste*.

Syringe

Forces the syringe to either *Load* or *Unload* the given *Amount [μl]*, or perform the *Home* operation (thy syringe will dispense itself into the last programmed position and will re-initialize).

Wash

Performs the standard wash operation. Specify the volume of the wash solvent in the *Amount [μl]* column.

Note: Program a *Dispense to Waste* action prior to washing to prevent the cross-contamination from the buffer solution.

Valve

Switches the injector valve or optional ISS valve to the desired position. The desired valve is set in the *Valve* column, while the position is specified in the *Position* column. To be able to program ISS valve it is necessary to have it installed.

Wait

Causes the sampler to wait for the specified time interval. The desired interval is entered into the *Time [min.]* column in minutes.

Note: The syringe will move to the *Home* position during the wait interval if the previous step was the *Aspirate* or *Dispense* step. If you want the syringe to stay at the same position, an *Aspirate* or *Dispense* step of *0 μl* is needed at that position before the *Wait* command.

Compress

Activates the compressor to put the air pressure on the sample. The compressor stays switched on until it is switched off (in some later step) or until needle wash operation end.

Aux

Controls the standard auxiliary outputs. Define which of the four outputs is to be changed in the *Aux Number* column and select the desired position in the *Position* column.

Wait Input

Sets the pause in which the sampler waits before proceeding until the input specified in the *Input Number* column is set into the position specified in the *Position* column.

Prog-Out

Controls the two outputs (contact closures) similar to auxiliary outputs, but only available in the *User Program* mode.

Code

Programs the output to the hex output connector in the range 0 - 15.

Marker

Sets the marker in the *Position* column to *Inject*, *Vial* and *Labeled Vial*.

Caution: When setting the **User Program**, *Markers* have to be used to signal the injection. This operation is performed automatically in other programs, but has to be performed manually in the **User Program** as the user has full control of the injection valve settings.

SSV

Defines the optional SSV valve position in the range 1-6 specified in the *Position* column. To be able to program SSV valve it is necessary to have it installed.

4.1.5 System

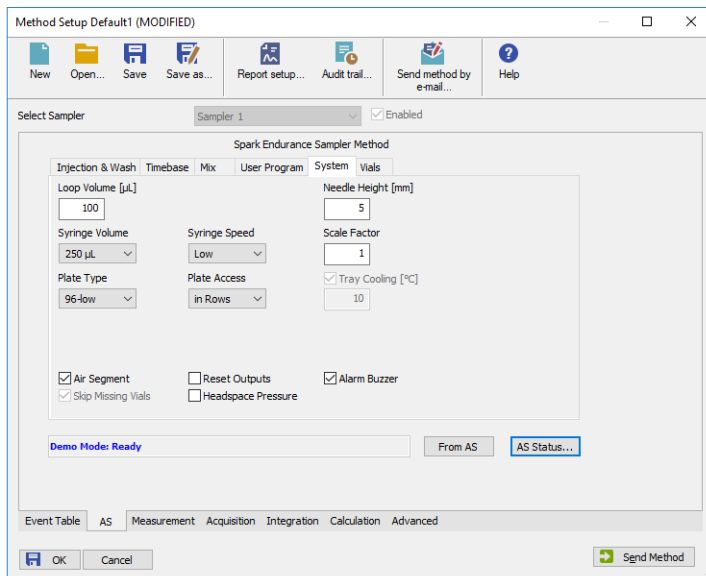

Fig 11: Method Setup - AS - system

Tab defining various aspects of the **Spark Endurance** operation.

Loop Volume [µl]

Defines the value of the loop volume used for the injection (in µl). Possible values range between 0.1 and 1000 µl. When using *Full Loop Injection Mode* from the [Method Setup - Injection & Wash](#) tab, only the *Loop Volume* value is allowed in the **Sequence Table** in the [Sequence](#) window.

Needle Height [mm]

Sets the distance of the needle tip from the reference point (2.5 mm above the tray bottom) during the aspiration. Possible values range from 0 to 40 mm.

Syringe Volume

Defines the volume of the syringe installed in the autosampler. Possible values are: 100 µl, 250 µl, 500 µl, 1000 µl, 10 ml.

Syringe Speed

Sets the syringe speed from the set of predefined values (*Low*, *Normal*, *High*). This speed can be further reduced by the use of the *Scale Factor* function.

Scale Factor

Sets the multiplier for the syringe speed. This variable can be set to values between 0.1 and 1, thus reducing the *Syringe Speed* set from one-tenth to

no speed reduction. The default value is 1.

Plate Type

Sets the plate type used with the **Spark Endurance** autosampler. Possible options are *96-low* (default), *96-high*, *384-low* and *48-vials*.

Plate Access

Defines the calculation system through the wells on installed plates. Possible options are *in Columns* (where the wells are counted from top to bottom) or *in Rows* (where they are numbered from left to right).

Tray Cooling [°C]

Allows to enable the tray cooling function and set the temperature for the cooling (in the range 4 - 40 °C). This option is grayed-out if the **Spark Endurance** sampler doesn't have the function built-in.

Air Segment

Sets whether the air segment should be used during the injection.

Reset Outputs

While checked, forces the digital outputs to be reset after the sequence has ended.

Alarm Buzzer

Sets the sound signalization on. See **Endurance** manual for more details.

Skip Missing Vials

Sets the behavior of the sampler during the sequence if empty vial is met. While checked, empty vial will be skipped and the sequence will continue on, while in other case the missing vial will stop the sequence, issuing an error message. This option is only modifiable when the *Sequence Mode* is set in the [Spark Autosampler Setup](#) dialog.

Headspace Pressure

When checked, the sampler uses the pressure to facilitate the transfer of the sample into the sample loop. The pressure will only be used when the vials are airtight.

4.1.6 Vials

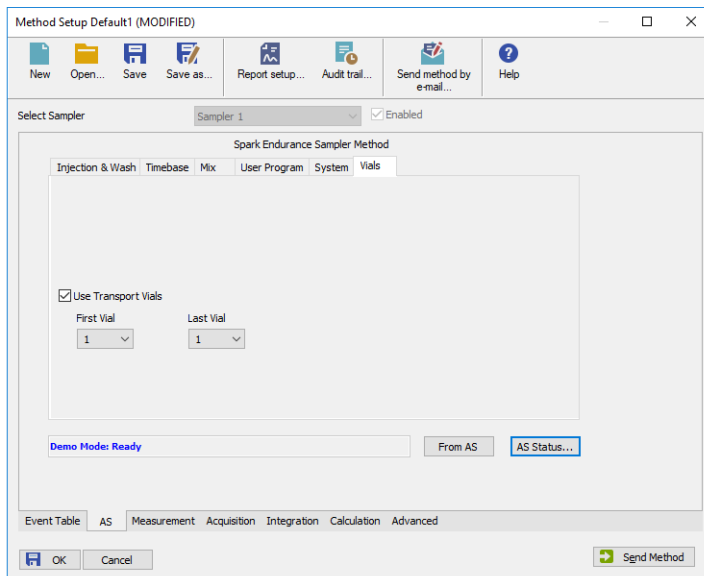

Fig 12: Method Setup - AS - Vials

Governs the allocation of special purpose vials (transport vials) to particular vial well positions.

Use Transport Vials

Defines the position of vials containing the transport liquid (used with μ l *Pick up* injection mode). The algorithm defining from which vial will the transport liquid be actually aspirated is stored in the **Spark Endurance** sampler. If the transport vials are used, they must form an uninterrupted row beginning in the well number defined by the *First Vial* field and ending by the vial defined in the *Last Vial* field.

4.2 Hardware Configuration

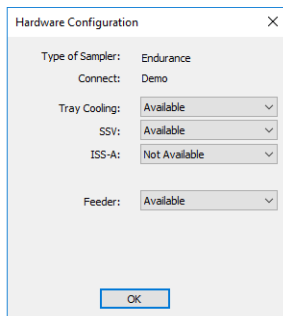

Fig 13: Hardware Configuration

The **AS Status** button in the **Method Setup - AS** displays the **Hardware Configuration** dialog. In the full version, this dialog displays autosampler model, automatically detected communication parameters and the presence of several optional parts of the **Spark Endurance** autosampler. In the demo version the presence of the particular options can be set to demonstrate the possibilities of the sampler with selected configuration.

Type of Sampler

Control module will automatically detect the **Spark Endurance** autosampler.

Connect

Shows the communication parameters in the format: [COMX, <baud rate>, <parity>, <data bits>, <stop bits>] or, in the demonstration regimes, [Demo] or [Offline].

Tray Cooling

Shows whether the **Spark Endurance** sampler is equipped with the tray cooling option.

SSV

Shows whether the **Spark Endurance** sampler is equipped with the solvent selection valve (SSV).

ISS-A

Shows whether the **Spark Endurance** sampler is equipped with the optional integrated stream-switching (ISS) valve.

Feeder

Shows whether the **Spark Endurance** sampler is equipped with the optional plate feeder for the support of additional sample plates.

4.3 Spark Autosampler Setup

Spark Autosampler Setup dialog (accessible through the **System Configuration** dialog) allows to manually set the parameters needed for the communication with the **Spark Endurance** autosampler.

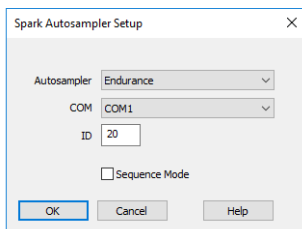

Fig 14: Spark Autosampler Setup

Autosampler

Sets the type of the **Spark Endurance** dialog. The possible options are *Endurance* or *Micro Endurance*. The selection may then influence the available options set in the method file.

COM

Sets the COM Port used for the communication between the **Spark Holland Endurance** sampler and the **Clarity**.

ID

Sets the device identifier of the Spark Endurance autosampler. The number listed here must be the same as the one set in the sampler. For more details see the chapter **Spark Endurance setup - communication** on pg 4.

Sequence Mode

This option governs the mode of the operation with the **Spark Endurance** autosampler control module. While checked, The whole sequence is sent to the autosampler in one package (no method sending prior each injection will be from then on performed). The sequence can use only one line in the sequence table, but multiple injections from the same row may be readily used.

While not checked, the operation will be governed by **Clarity** - the method will be sent to the autosampler prior each injection and each injection will thus be considered a single one-injection series by the autosampler. This prevents the use of washing between samples and few other features.

5 Report Setup

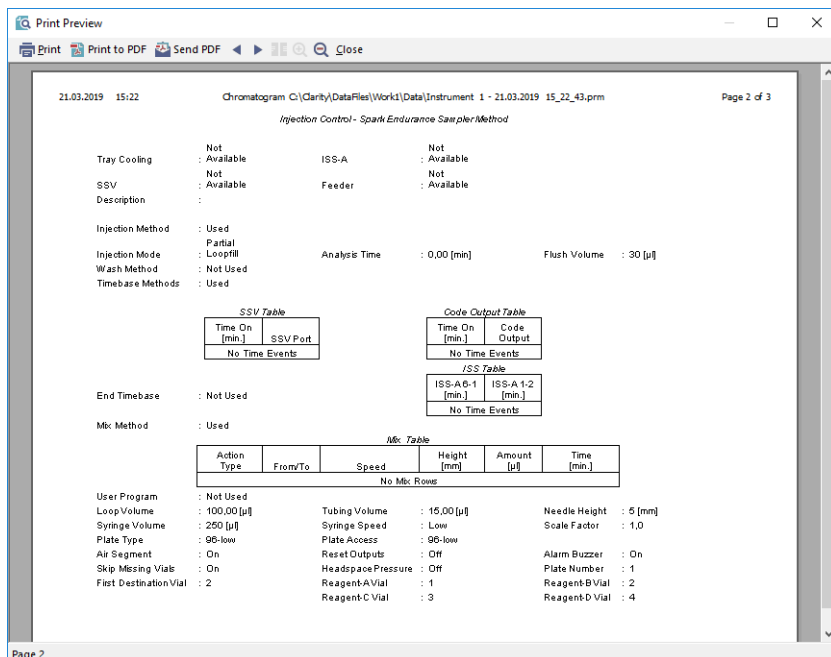

Fig 15: Spark Endurance report preview

All autosampler-specific settings (that means the data from all sub-tabs of the **Method Setup - AS** tab) are reported as a part of the data displayed by the use of *Injection Control* checkbox of the **Report Setup - Method** dialog.

6 Troubleshooting

When the remedy for some problem cannot be discovered easily, the recording of communication between **Clarity** and the autosampler can significantly help the **DataApex** support to discover the cause of the problem.

The recording can be enabled by adding or amending the COMMDRV.INI file in the **Clarity** installation directory (C:\CLARITY\CFG by default). The file can be edited in any text editor (e.g. Notepad). Following section should be edited or added:

```
[COM1]
echo=on
textmode=on
filename=SparkEndurance_%D.txt
reset=off
```

Note: Instead of COM1 type the correct serial port used to communicate with the **Spark Endurance** autosampler. This port number is displayed when the *AS Status* button in the [Method Setup - AS](#) dialog is invoked or in the [Spark Autosampler Setup](#) dialog.

Note: %D (or %d) in the filename parameter means that the log will be created separately for each day. The *reset=off* parameter disables deleting the content of the log each time the station is started during the same day.

The created *.TXT files will greatly help in diagnosis of unrecognized errors and problems in communication.

6.1 Specific Problems

An error message “Cannot establish communication with ...” appears when opening Clarity Instrument.

Solution: Check the power cable (**Spark Endurance** sampler must be switched on), communication cable and communication settings (the autosampler must be in Serial mode, i.e. the "Serial mode" inscription must be shown on the Autosampler display). If it is not, switch it on.

An error message “AS Error” appears during the Clarity operation.

Solution: The communication has been interrupted. Check the communication cable as it is most probably disconnected. This message may also occasionally appear after aborting the *ACTIVE* Sequence.

Injection volume set in the [Sequence](#) window is not accepted.

Solution: Either you are using the *Flushed Loop* option and the injection volume doesn't the one of the installed injection loop, or you are trying to enter the volume that is greater than the half of the installed *Loop Volume* in the *Partial Loopfill* injection mode.

The Spark Endurance autosampler does not start with the injection.

Solution: Check the Freeze input active settings in the I/O configuration of the **Spark Endurance** autosampler. When set to *HIGH*, the injection will not start until the respective input is closed. For more details on how to check the I/O configuration see the **Spark Endurance** manual.